

# Hisense

---

PARTY SPEAKER SYSTEM

Model: HP130

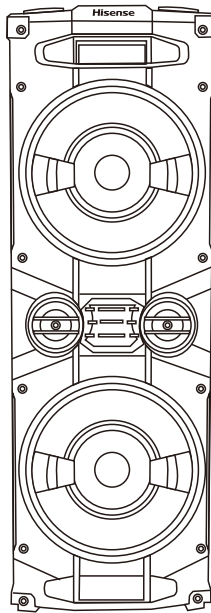

---

## USER MANUAL

---



Read all the safety instructions carefully before use and keep this instruction manual for future reference



# Contents

EN

<b>Important Safety Instructions</b>	<b>2</b>
<b>Features</b>	<b>4</b>
Package Contents .....	4
<b>Product Diagram</b>	<b>5</b>
Main Unit .....	5
Main Unit .....	6
<b>Connections</b>	<b>7</b>
Connect Power .....	7
Use the <b>LINE IN/AUDIO IN</b> Socket .....	7
Use the <b>MIC IN</b> Socket .....	8
Use the <b>GUITAR IN</b> Socket .....	8
<b>Basic Operation</b>	<b>9</b>
Standby/ON.....	9
Select Modes.....	9
Adjust the Volume.....	9
Preset Equalizer .....	9
Bass settings .....	9
Adjust the LED light .....	9
<b>LINE IN Operation</b>	<b>9</b>
<b>FM Radio Operation</b>	<b>9</b>
<b>Bluetooth Operation</b>	<b>10</b>
Pair Bluetooth-enabled Devices.....	10
Listen to Music from Bluetooth Device .....	10
<b>USB Operation</b>	<b>11</b>
<b>Troubleshooting</b>	<b>12</b>
<b>Specifications</b>	<b>13</b>

# Important Safety Instructions

EN



**CAUTION**  
**RISK OF ELECTRIC SHOCK**  
**DO NOT OPEN**



CAUTION: TO REDUCE THE RISK OF ELECTRIC SHOCK, DO NOT REMOVE COVER (OR BACK). NO USER-SERVICEABLE PARTS INSIDE. REFER SERVICING TO QUALIFIED SERVICE PERSONNEL.



The lightning flash with arrowhead symbol, within an equilateral triangle, is intended to alert the user to the presence of uninsulated "dangerous voltage" within the product's enclosure that may be of sufficient magnitude to constitute a risk of electric shock to persons.



The exclamation point within an equilateral triangle is intended to alert the user to the presence of important operating and maintenance (servicing) instructions in the literature accompanying the appliance.

## Safety

- 1 Read these instructions – All the safety and operating instructions should be read before this product is operated.
- 2 Keep these instructions – The safety and operating instructions should be retained for future reference.
- 3 Heed all warnings – All warnings on the appliance and in the operating instructions should be adhered to.
- 4 Follow all instructions – All operating and use instructions should be followed.
- 5 Do not use this apparatus near water – The appliance should not be used near water or moisture – for example, in a wet basement or near a swimming pool, and the like.
- 6 Clean only with dry cloth.
- 7 Do not block any ventilation openings. Install in accordance with the manufacturer's instructions.
- 8 Do not install near any heat sources such as radiators, heat registers, stoves, or other apparatus (including amplifiers) that produce heat.
- 9 Danger of explosion if battery is incorrectly replaced. Replace only with the same or equivalent type.
- 10 Do not defeat the safety purpose of the polarized or grounding plug. A polarized

plug has two blades with one wider than the other. A grounding plug has two blades and a third grounding prong. The wide blade or the third prong is provided for your safety. If the provided plug does not fit into your outlet, consult an electrician for replacement of the obsolete outlet.

- 11 Protect the power cord from being walked on or pinched particularly at the plugs, convenience receptacles, and at the point where they exit from the apparatus.
- 12 Only use attachments/accessories specified by the manufacturer.
- 13 Use only with the cart, stand, tripod, bracket, or table specified by the manufacturer, or sold with the apparatus. When a cart or rack is used, use caution when moving the cart/apparatus combination to avoid injury from tip-over.
- 14 Unplug the apparatus during lightning storms or when unused for long periods of time.
- 15 Refer all servicing to qualified personnel. Servicing is required when the apparatus has been damaged in any way, such as power supply cord or plug is damaged, liquid has been spilled or objects have fallen into the apparatus has been exposed to rain or moisture, does not operate normally, or has been dropped.
- 16  This equipment is a Class II or double insulated electrical appliance. It has been designed in such a way that it does not require a safety connection to electrical earth.
- 17 To reduce the risk of fire or electric shock, do not expose this apparatus to rain or moisture. The apparatus must not be exposed to dripping or splashing and objects filled with liquids, such as vases, must not be placed on apparatus.
- 18 The mains plug is used as the disconnect device, the disconnect device shall remain readily operable.

## Warning

- The battery (batteries or battery pack) shall not be exposed to excessive heat such as sunshine, fire or the like.
- These servicing instructions are for use by qualified service personnel only. To reduce the risk of electric shock, do not perform

# Important Safety Instructions



The Bluetooth® word mark and logos are registered trademarks owned by Bluetooth SIG, Inc. We are the licensee to use such marks. Other trademarks and trade names are those of their respective owners.

EN

any servicing other than that contained in the operating instructions unless you are qualified to do so.

- Avoid foreign bodies and liquids entering the device.
- Do not place open e.g. lit candles, on or directly adjacent to the device.
- Do not use any corrosive or abrasive cleaning agents. These could damage the surface of the device.
- Please refer the information on exterior bottom or rear enclosure for electrical and safety information before installing or operating the apparatus.
- Minimum distance around the apparatus for sufficient ventilation is 5cm;
- The ventilation should not be impeded by covering the ventilation openings with items such as newspaper, table-cloths, curtains etc.
- No naked flame sources such as lighted candles should be placed on the apparatus;
- Batteries should be recycled or disposed of as per state and local guidelines;
- The use of apparatus in moderate or tropical climates.
- The marking label is pasted on the bottom or back of the equipment.

## **WARNING**

### **DO NOT INGEST BATTERY, CHEMICAL BURN HAZARD**

If you think batteries might have been swallowed or placed inside any part of the body, seek immediate medical attention. Keep new and used batteries away from children. If the battery compartment does not close securely, stop using the product and keep it away from children. The remote control supplied with this product contains a coin/button cell battery. If the coin/button cell battery is swallowed, it can cause severe internal burns in just 2 hours and lead to death.



Correct Disposal of this product. This marking indicates that this product should not be disposed with other household wastes throughout the EU.

To prevent possible harm to the environment or human health from uncontrolled waste disposal, recycle it responsibly to promote the sustainable reuse of material resources. To return your used device, please use the return and collection systems or contact the retailer where the product was purchased. They can take this product for environmental safe recycling.

## **FCC INFORMATION (for US customers)**

### **Warning:**

Changes or modifications to this unit not expressly approved by the party responsible for compliance could void the user's authority to operate the equipment."

### **NOTE:**

- This equipment has been tested and found to comply with the limits for a Class B digital device, pursuant to Part 15 of the FCC Rules. These limits are designed to provide reasonable protection against harmful interference in a residential installation. This equipment generates, uses and can radiate radio frequency energy and, if not installed and used in accordance with the instructions, may cause harmful interference to radio communications.
- However, there is no guarantee that interference will not occur in a particular installation. If this equipment does cause harmful interference to radio or television reception, which can be determined by turning the equipment off and on, the user is encouraged to try to correct the interference by one or more of the following measures:
  - Reorient or relocate the receiving antenna.
  - Increase the separation between the equipment and receiver.
  - Connect the equipment into an outlet on a circuit different from that to which the receiver is connected.
  - Consult the dealer or an experienced radio / TV technician for help.
- This device complies with Part 15 of the FCC Rules. Operation is subject to the following two conditions:
  - (1) this device may not cause harmful interference, and
  - (2) this device must accept any interference received, including interference that may cause undesired operation.
- Shielded cables must be used with this unit to ensure compliance with the Class B FCC limits.

## Features

Thanks for your purchase of our product. Please read through this manual before making connections and operating this product. Retain this manual for future reference.

EN

- Bluetooth playback
- AUDIO/LINE input
- FM tuner
- USB slot
- Microphone function
- Guitar function
- Multiple EQ sound effect mode

## Package Contents

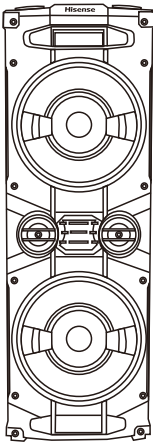

Main Unit

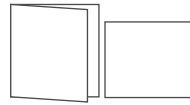

User Manual  
Warranty Card



AC power cord

# Product Diagram

## Top View

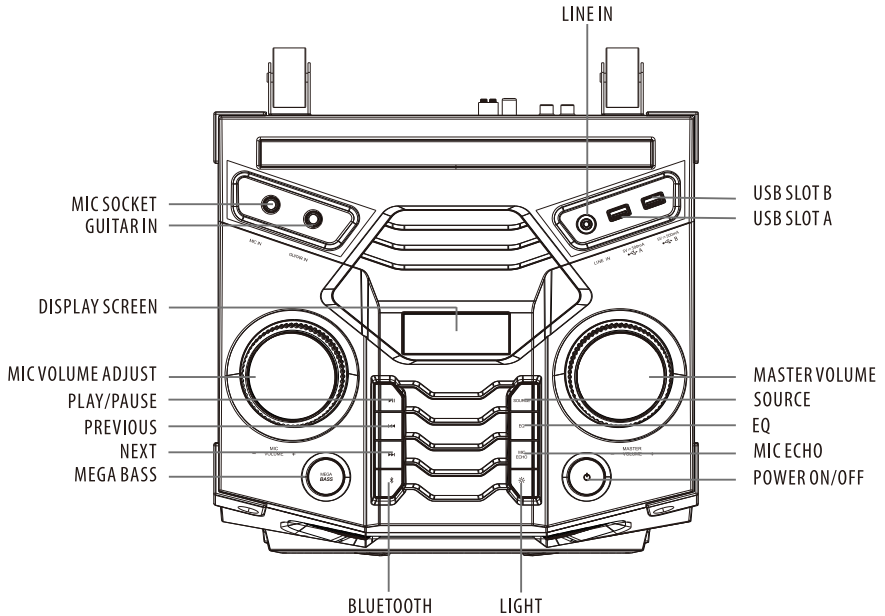

EN

## HP130 Port

MIC SOCKET	Mic socket	LIGHT	Select the different lighting mode of LED indicator
GUITAR IN	Guitar in socket	LINE IN	LINE IN jack
DISPLAY SCREEN	DISPLAY SCREEN	USB SLOT A	USB slot A
MIC VOLUME ADJUST	Increase/decrease the mic volume level	USB SLOT B	USB slot B
PLAY/PAUSE	Play/pause playback.	MASTER VOLUME	Increase/decrease the volume level
PREVIOUS	Press to the previous track	SOURCE	Select a play function
NEXT	Press to the next track.	MIC ECHO	ON/OFF microphone mode
MEGA BASS	ON/OFF the MEGA BASS mode	EQ	equalizer manual mode
BLUETOOTH	BLUETOOTH	POWER ON/OFF	POWER ON/OFF

# Product Diagram

## Rear View

EN

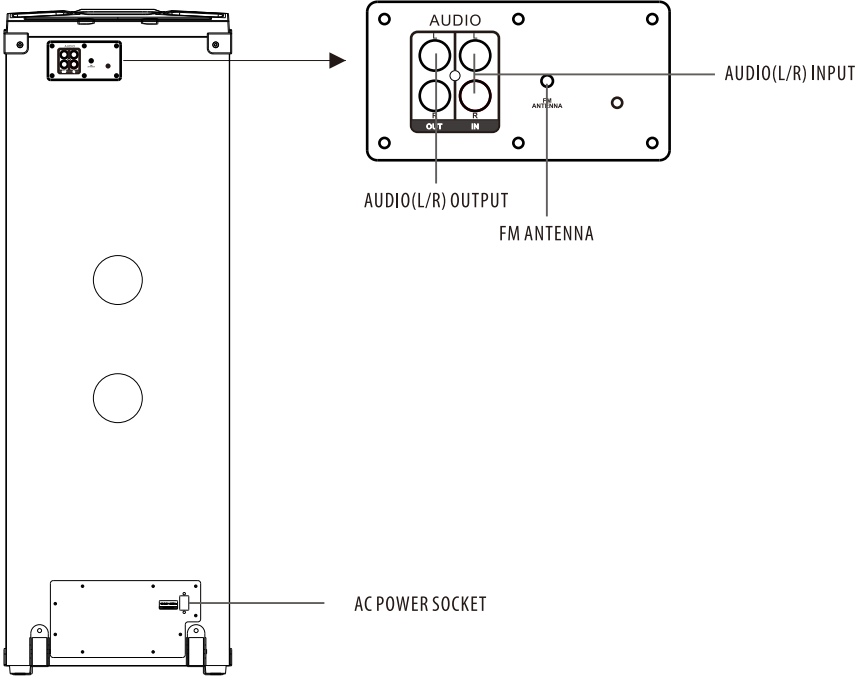

## HP130 Port

AUDIO(L/R) OUTPUT	AUDIO(L/R) output	FM ANTENNA	FM antenna
AUDIO(L/R) INPUT	AUDIO(L/R) input	AC POWER SOCKET	AC power socket



# Connections

## Connect Power

Rear panel of the main unit

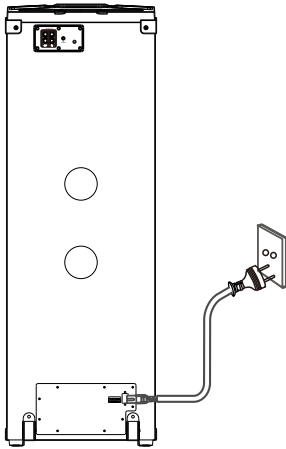

### Risk of product damage!

Ensure that the power supply voltage corresponds to the voltage printed on the back or the underside of the unit.  
-Insert the AC power cord into a mains socket .

EN

## LINE IN/AUDIO IN Socket

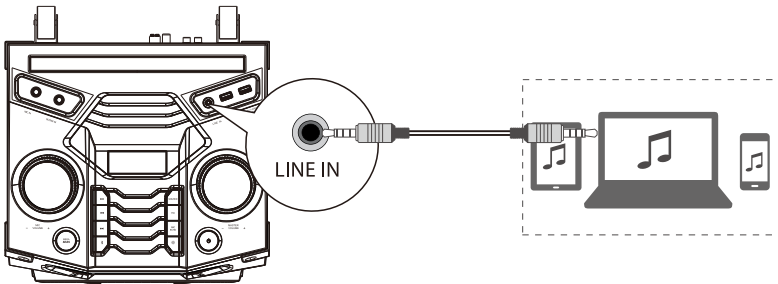

Rear View of the Main Unit

Rear View of another Main Unit (not included)

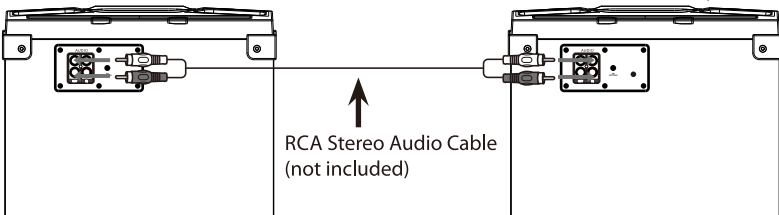

### LINE IN/AUDIO IN

This unit have two audio input terminals. You can input the analogue stereo audio signals from extra devices such as VCD, CD, VCR, MP3 player, etc.

Use the audio cable to connect the input terminal LINE IN/AUDIO IN on the top panel/on the unit, press [SOURCE] button to switch to the LINE IN/AUDIO IN mode when the display screen on the unit appear "LINE/AUDIO"

## Connections

EN

### MIC Socket

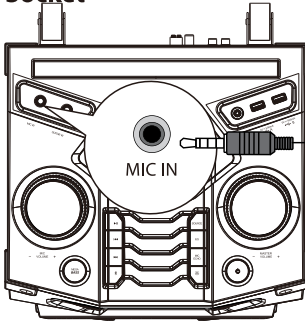

Insert the **microphone** into the microphone socket on the top panel and adjust to a low level **using** the microphone volume knob on the top panel.

Adjust the microphone volume level to your desired level **using** the microphone volume knob on the top panel.

Now, enjoy the karaoke singing!

### GUITAR IN Socket

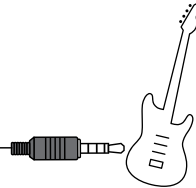
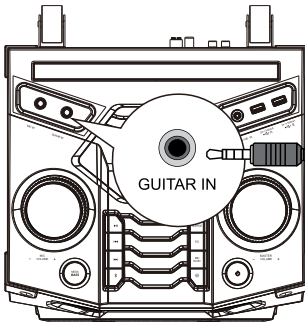

Insert the guitar cable into the guitar socket on the top panel.

Now, enjoy yourself!

## Basic Operation

### Standby/ON

- When you first connect the unit to the main socket, the unit will be in STANDBY mode. The POWER indicator will light up red.
- Press the SOURCE button on the unit to switch the main unit ON / OFF.
- Disconnect the main plug from the main socket if you want to switch the unit off completely.
- **When there is no input signal from the unit more than 15 minutes, it will switch to Standby mode automatically.**

### Select Modes

- Press the SOURCE button on the unit to select the play function Bluetooth ,LINE IN ,AUDIO IN,USB A,USB B and TUNER mode.

### Adjust the Volume

- Turn the **VOL+/VOL-** dial on the unit to adjust the volume.

### Preset Equalizer

- During play, press the EQ button repeatedly to select: ROCK-JAZZ-POP-SAMBA-BALANCE

### Bass settings

- Press MEGA BASS button to select BASS ON/ BASS OFF

### Adjust the LED light

- Press the  button repeatedly to select the LED effect between LED OFF, LED1, LED2, LED 3, LED 4, LED 6.

EN

## LINE IN Operation



- 1 Ensure that the unit is connected to the TV **or the other audio devices.**
- 2 Press the **SOURCE** button on the unit to select the **LINE IN** mode.
- 3 Operate your audio device directly for playback features.
- 4 Press the **VOL +/-** button to adjust the volume to your desired level.

## FM Radio Operation

Press **SOURCE** button repeatedly to select the tuner source. The display will show "TUNER".



### TUNING in a Station

#### Auto Tuning

- 1 Press and hold  button to start auto tuning. Press  button again to stop the auto tuning.
- 2 The searched radio stations will be stored as preset **stations.**

Note: The search may not stop at a station with a very weak signal.

#### Manual Tuning

Press and hold  or  button to start the forward or reverse scanning. The display will show the frequency being searched. Once a station has been found, the scanning will stop automatically to change the frequency until you find the station you want.

# Bluetooth Operation

## Pair Bluetooth-enabled Devices

The first time you connect your Bluetooth device to this player, you need to pair your device to this player.

### Note:

- The operational range between this player and a Bluetooth device is approximately 8 meters (without any object between the Bluetooth device and the unit).
  - Before you connect a Bluetooth device to this unit, ensure you know the device's capabilities.
  - Compatibility with all Bluetooth devices is not guaranteed.
  - Any obstacle between this unit and a Bluetooth device can reduce the operational range.
  - If the signal strength is weak, your Bluetooth receiver may disconnect, but it will re-enter pairing mode automatically.
- 1 Press the **SOURCE** on the unit to select **Bluetooth** mode.
  - 2 The word "**NO BT**" will be shown on the display screen, the system has entered pairing mode.
  - 3 Activate your Bluetooth device and select the search mode. "**HP130**" will appear on your Bluetooth.
  - 4 Select "**HP130**" in the pairing list, the system is successfully connected and the word "**CONNECTED**" will be shown on the display screen.
  - 5 Begin playing music from the connected Bluetooth device.

### To disconnect the Bluetooth function, you can :

- Switch to another function on the unit.
- Disable the Bluetooth function on your device.
- Press and hold the "  " button on the unit.

### Tips:

- Enter "0000" for the password if necessary.
- If no other Bluetooth device pairs with this player in 2 minutes, the player will reconnect to the previous connection.
- The player will also be disconnected when your device is moved beyond the operational range.
- If you want to reconnect your device to this player, place it within the operational range.
- If the device is moved beyond the operational range, when it is brought back, please check if the device is still connected to the player.
- If the connection is lost, follow the instructions above to pair your device to the player again.

## Listen to Music from Bluetooth Device

If your Bluetooth device supports A2DP, play music via your device.

- To pause/resume playback, press **▶||**
- To skip to a track, press **◀◀** or **▶▶**
- Turn the **VOL+/-** dial to increase or decrease the volume.

# USB Operation

## USB Operation

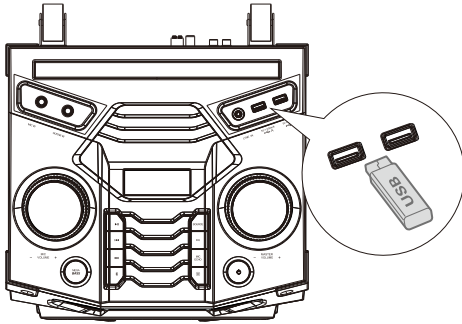



EN

- 1 Insert the USB device.
  - 2 Play starts automatically. If play **does** not start automatically, press ►|| button.
- To skip to the previous/next track, press the ◀◀/▶▶ buttons on the unit.

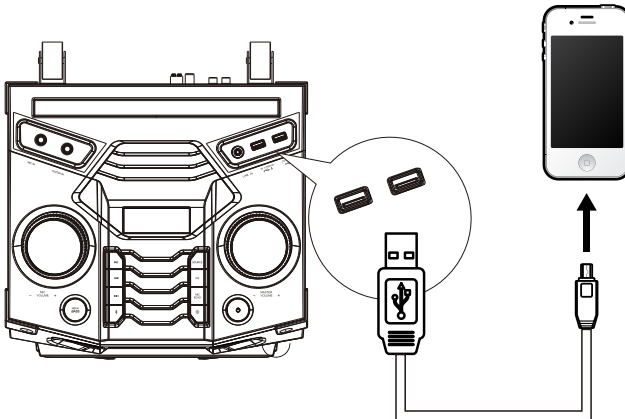
## Charging from the USB Port



The Charging  5V 0.5A socket is designed for charging mobile devices(e.g. Mp3 player, mobile phone, etc). It supplies 5V DC at a charging current of up to 500mA(0.5A). Use a USB cable (not included) to connect mobile device to Charging  5V 0.5A Socket of the unit and the mobile device will start charging.

# Troubleshooting

To keep the warranty valid, never try to repair the system yourself. If you encounter problems when using this unit, review the following before requesting service.

## No power

- Ensure that the AC cord is properly connected.
- Ensure that there is power at the AC outlet.
- **Press standby button on the speaker.**

## No sound

- Increase the volume.
- Press source **button** to select a different input source.
- When using either of the Digital input, if there is no audio:
  - Try setting the TV output to PCM or
  - Connect directly to your Blu-ray/other source, some TVs do not pass through digital audio.
- Your TV may be set to variable audio output. Confirm that the audio output setting is set to FIXED or STANDARD, not VARIABLE. Consult your TV's user manual for more detailed **informations**.
- If using Bluetooth, ensure that the volume on your source device is turned up and that the device is not muted.

## I hear buzzing or humming

- Ensure all cables and wires are securely connected.
- Connect a different source device (TV, Blu-ray player, etc) to see if the buzzing persists. If it does not, the problem may be with the original device.
- Connect your device to a different input on the **speaker**.

## I can't find the Bluetooth name of this unit on my Bluetooth device

- Ensure the Bluetooth function is activated on your Bluetooth device.
- Re-pair the unit with your Bluetooth device.

# SPECIFICATONS

Model name	HP130
------------	-------

## Power supply

Voltage	AC 100-240 V ~ 50/60Hz
Power consumption	200 W
Dimensions(W x H x D)	326x953x340mm

## Amplifier

Output power	4 x 100 W RMS
--------------	---------------

## Ambient conditions

In operation	min. 0°C – max. +35°C / 60% relative humidity
Not in operation	min. -10°C – max. +45°C / 65% relative humidity

## Radio

FM band	FM 87.5 – 108 MHz.
FM antenna	Permanently installed wire aerial

## Connections

LINE input	3.5mm jack
Microphone input	6.3mm jack
Guitar input	6.3mm jack
AUDIO IN	RCA input
AUDIO OUT	RCA output

## System

Frequency range	40Hz to 18KHz $\pm$ 3dB
Signal-to-noise	$\geq$ 65dB
USB port	USB 2.0 to 32 GB
USBA/B output	Output: 5V 1A max.

## Bluetooth®

Bluetooth Version	5.0
-------------------	-----

***Hisense***  

---

**HP130**

Model: PARTY SPEAKER SYSTEM