

Hisense U71 (HWCD119E)

User Manual

Before using your phone, read the User Manual thoroughly.

Manufactured by Hisense International Co., Ltd.

Contents

Phone Basics

Your phone at a glance	5
Carrying out basic operations	6
Using the notification center	11
Using SIM and MicroSD cards	12
Battery charging	14

Troubleshooting

I can't turn my phone on	16
My phone keeps turning off automatically	17
I can't use an application on my phone	17
My phone's standby time is too short	17
My phone isn't charging properly	18
Touchscreen error when charging	18
I've forgotten my password	19
My PIN is locked	19
I can't use the Internet or make calls	19
My calls don't connect	20
Phone doesn't make a sound when it rings	20

Phone

Making calls	20
Making calls from contacts	20
Making calls from recents	21

Contacts

Importing contacts	21
Creating contacts	21
Searching for contacts	22

Messages

Sending messages	22
Viewing messages	23

Camera

Taking photos	23
Recording videos	24

Photos

Viewing photos or videos	24
Deleting photos or videos	24

Sharing photos or videos	25
Chrome	
Using Chrome	25
Clock	
Alarm	25
Clock	26
Timer	27
Stopwatch	27
Sound Recorder	
Recording sound	27
Playing a recording	28
Managing recordings	28
Calculator	
Making calculation	28
FM Radio	
Listening to radio	29
Safety	
Safety precautions	29
Safe battery charging	33
Protecting your hearing	33
Protecting the environment	34
Specific Absorption Rate (SAR)	34
Reducing your radiation exposure	35
Other important information	35
Disclaimer	36
Frequency bands and power	38
Compliance	39
EU Declaration of Conformity (DoC)	40

Safety symbols in this document

The following symbols are used throughout this document:



Warning: situations that could cause injury to yourself or others.



Caution: situations that could cause damage to your device or other equipment.



Notice: notes, usage tips, or additional information.

Phone Basics

Use the information in this section to get to know your phone better.

Your phone at a glance

Get to know your phone with the following figure and legend.

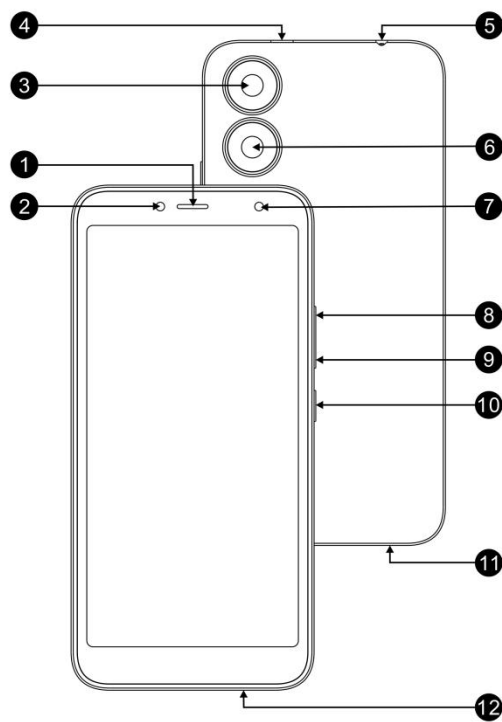

1.Receiver	7.Flashlight
2.Front camera	8.Volume button
3.Rear camera	9.Volume button
4.USB	10.Power button
5.Headset socket	11.Microphone
6.Flashlight	12.Loudspeaker



The figures and descriptions are for reference only, please refer to the descriptions of actual product.

Carrying out basic operations

This section describes how to perform basic functions on your phone.



Before using your phone for the first time, fully charge your battery. For more information on charging your battery, see

Battery charging.

Turning your phone on

- To turn your phone on, press and hold the power button until the screen turns on.
- When turning your phone on for the first time, or after performing data reset, follow the onscreen instructions to set up you phone.
- To force restart your phone, press and hold the power button for more than 10 seconds until your phone Reboot.

Turning your phone off

To power off your phone, press and hold the power button, and

then tap the icon  .

Using touchscreen gestures

This section describes how to use touchscreen gestures to help control your phone.

Tapping

To open an app, to choose a menu item, to press an on-screen button, or to enter a character using the keyboard on the screen, tap it with your finger.

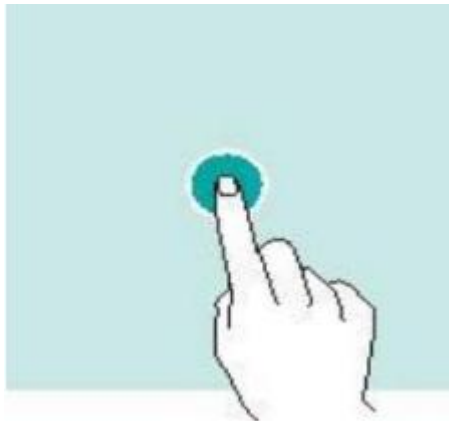

Tapping and holding

Tap and hold an item on the screen for more than 2 seconds to access available options.



Swiping

Swipe to the left or right on the home screen or the Apps screen to view other panels.

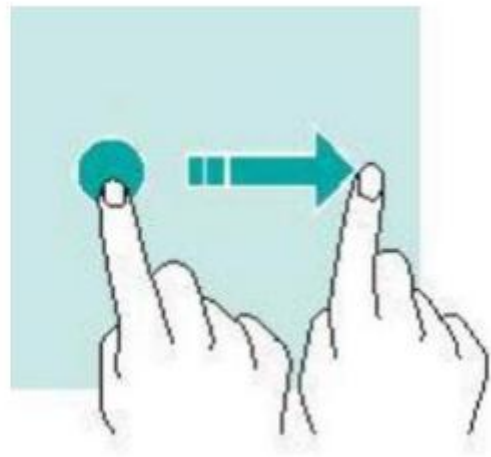
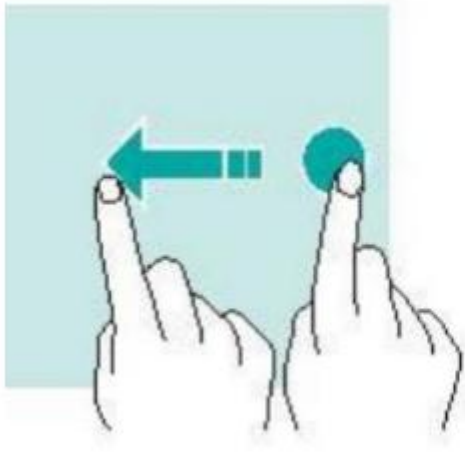

Swipe upwards or downwards to scroll through a web page or a list of items.

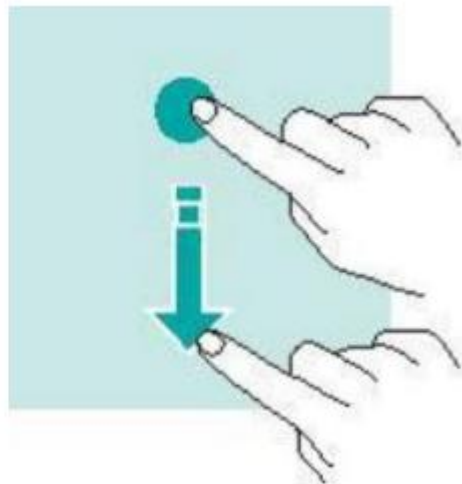
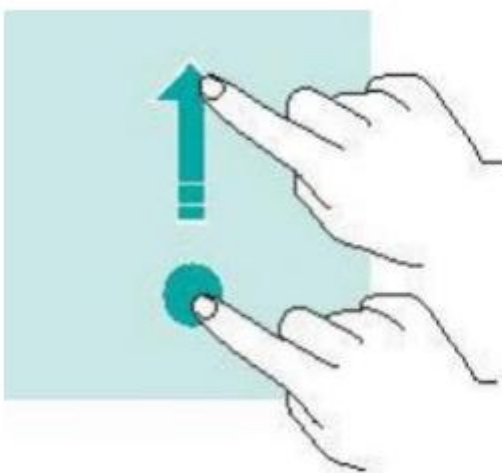

Spreading and pinching

Spread two fingers apart on a web page, map or image to zoom in a part.

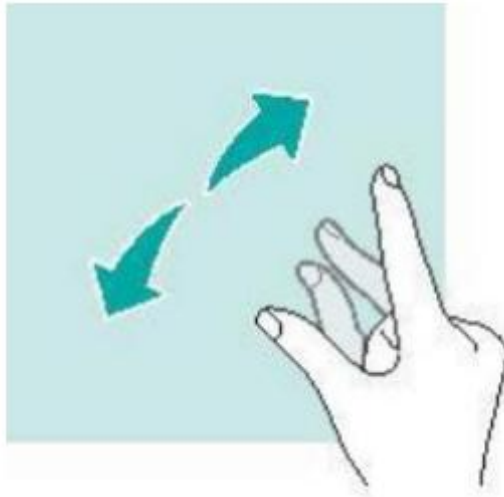

Pinch to zoom out.





Dragging

To move an item, tap and hold it and drag it to the target position.



Using the navigation bar

You can find your navigation bar control at the bottom of your screen.

- To go back to the home screen, tap .
- To open the list of recent apps, tap .
- To go back to the previous screen, tap .

Locking

Locking the screen

- To lock the screen, press the power button.

Unlocking the screen

To unlock the screen, press the power button and swipe up.

Using the notification center

The notification center is where you can view the latest notifications relating to the operation of your phone.

Opening the notification center

To open and view the notification center:

- 1** Swipe down from the top of the screen to see the notification center.
- 2** Swipe down again from the top of the screen to see the shortcuts tab.

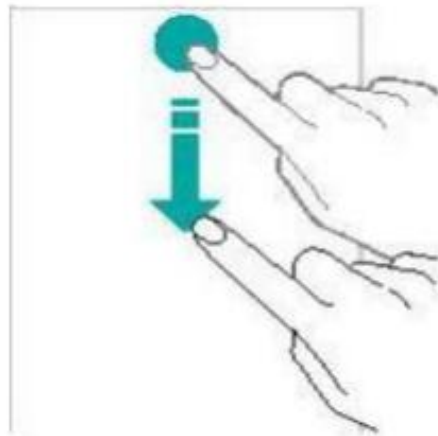

Closing the notification center

Swipe up or tap  to close the notification center.

Setting notification options

To set notification options, go to **Settings > Apps & notifications > Notifications**.

Using SIM and MicroSD cards

Inserting SIM and MicroSD cards

Always ensure that SIM and MicroSD cards are inserted correctly into your phone.

The following figure shows the correct way to insert SIM and MicroSD cards into your phone.

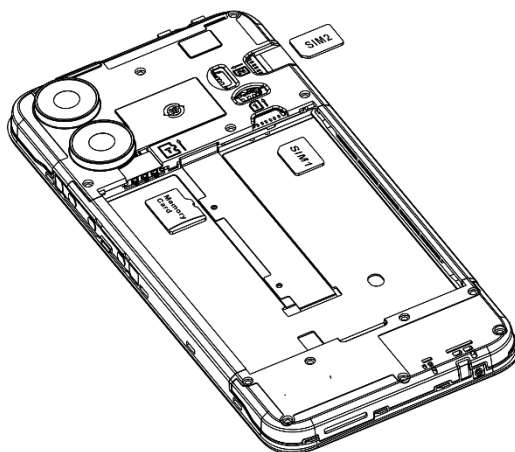

Insert the SIM card, please make sure that the direction of the SIM card is consistent with the direction on the card slot.



Do not use cut or modified SIM or MicroSD cards with your phone, as these may not be recognized and could damage the card tray.

Plug the SIM card and SD cards

Does not support hot swap. The following figure shows the exact positions of the SIM card slot and SD card slot, please standardize the insertion and removal operations.

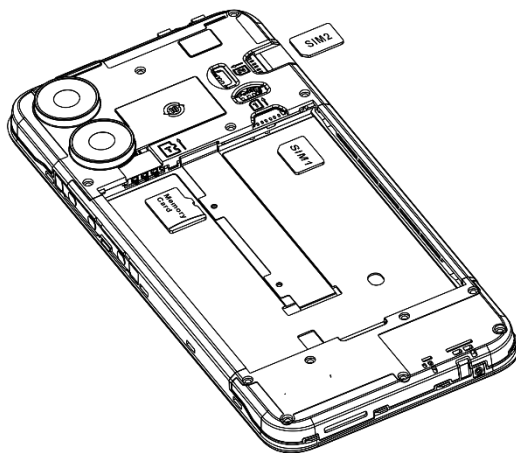

Battery charging

Follow instructions in this section to charge your battery safely and preserve battery life.

Charging your battery

Fully charge the battery before using it for the first time, or when the phone has not been used for a long time, or when the battery is low.

To charge your battery, do the following:

- 1** Connect your USB charging cable to your USB power adapter. Plug the end of the USB cable into the USB port, and the USB power adapter into a power socket.
- 2** Once your battery is fully charged, disconnect your phone from your USB charging cable.

Important safety precautions

The following precautions are extremely important and must be followed at all times:



Risk of explosion if battery is replaced by an incorrect type.

Dispose of used batteries according to the instructions.

To charge your phone safely, it is also important to pay attention to the following points:

- Use only approved chargers, batteries, and cables. Using an

unapproved or incompatible power adapter, charger, or battery may damage your phone, shorten its lifespan, or cause a fire, explosion or other hazards.

- Avoid using your phone when it is charging. Do not cover your phone or power adapter.
- Connect your charger properly. Not connecting your charger properly can cause serious damage to your phone. Any damage caused by misuse is not covered by the warranty.
- Your phone can be safely charged at temperatures between 0°C and 40°C. Charging in environment where the temperature is below 0°C or higher than 40°C will harm battery performance and shorten battery life. Regular, long-term charging in extreme temperatures will damage your battery.
- Unplug your charger from the electric socket when not charging your phone.

Protecting your battery

For safe and effective charging that also protects your battery, you must also pay attention to the following points:

- If your AC power supply is lower voltage, or you charge from computer or other non-standard sources, you may need to charge your phone for longer.
- Your phone might not start straight away if the battery is low. Your

phone will start normally once it has charged for a short while.

- The time your phone needs to charge may depend on room temperature and your battery level.
- The phone and charger may heat while charging. This is normal and shouldn't affect your phone's lifespan or performance. If your battery becomes much hotter than usual, stop charging your phone and put it in a cool place. If your phone surface is hot, avoid touching your phone for too long.

Troubleshooting

This section lists common problems you may have when using your phone. Check to see whether your issue is listed here before contacting the service center.

I can't turn my phone on

If you can't turn your phone on, try the following:

- Press and hold power key for two seconds or longer.
- Check that the battery is fully charged before turning your phone on.
- Press and hold the power button until your phone vibrates.
- Check that your battery is properly connected to your phone, and

that the connecting points are clean. If your phone has a built-in battery, contact the service center.

My phone keeps turning off automatically

If your phone keeps turning off automatically, try the following:

- Check your battery power. If the power is low, charge your phone.
- Check softwares or applications to see if they are normal. If not, restart your phone.

I can't use an application on my phone

If you can't use an application on your phone, try the following:

- Check if your phone has sufficient storage. Delete some messages from your phone.
- Check if the application is damaged. Uninstall and reinstall the application. If cannot be fixed, try resetting system.
- Chances are that the application is not compatible. Uninstall the application and choose a compatible version.
- Check and enable applications management permissions.

My phone's standby time is too short

If your phone's standby time is too short, try the following:

- Chances are that the battery performance decreases. Contact service center to change the battery.
- If you play games or listen to music for a long period of time,

shorten the time.

- If the screen is too bright, adjust the brightness of the screen.
- If the phone is used in weak signal environment, the standby time will be short. Please move to strong signal locations.
- Turn off cellular data, GPS, Bluetooth, Wi-Fi switch when not using them.
- Close the application not used.
- Uninstall the applications not used for a long period of time.

My phone isn't charging properly

If your phone isn't charging properly, try the following:

- Ensure that your phone is charging at a normal temperature.
- Plug the charger into a different socket.
- Recharge your phone for about half an hour.
- Chances are that the battery has a problem. If the battery has been built-in, contact service center.
- Ensure that the charger is not defective. If the charger is defective, replace it.
- If the charger fails to charge, please change or repair it.

Touchscreen error when charging

If there is touchscreen error when charging, try the following:

- If the charging equipment is incompatible with your phone, it may

cause some problems. Use charger supplied and stable charging equipment.

- Check whether softwares or applications are normal or not. Restart your phone.

I've forgotten my password

If you forget your password, contact service provider.

My PIN is locked

If you enter wrong PIN three times in a row, contact service provider.

I can't use the Internet or make calls

If you can't use the Internet or make calls, try the following:

- Chances are that signal is too weak. Move to an open area and try again.
- Chances are that the phone is out of service area. Check if the Internet is available.
- Chances are that airplane mode is on. Turn off airplane mode.
- Check if software is abnormal. If so, restart the phone.
- Check if SIM card has failure. If so, check or change SIM card.
- Ensure that the dialing is right.
- Check if cellular data setting has failure. If so, go to Settings to set

up cellular data.

- Check if prepaid charge has reached its limit. If so, contact service provider.

My calls don't connect

If your calls don't connect, try the following:

- Check if phone number is too long.
- Ensure international roaming service and international call service are enabled. If not, contact service provider.



Phone doesn't make a sound when it rings

If your phone doesn't make a sound when it rings, check if silent or vibrate mode is enabled.

Phone



Making calls

To make calls:

- 1 Tap .
- 2 Tap  to enter a phone number.
- 3 Tap  to make a call.



Making calls from contacts

To make calls from contacts:

- 1 Tap .
- 2 Tap  to choose a contact.
- 3 Tap the contact number.

Making calls from recents



To make calls from call logs:

- 1 Tap .
- 2 Tap  to view all calls. Tap the name or number of the person you want to call.
- 3 Tap .

Contacts

Importing contacts

To import contacts to your phone:

- 1 Tap .
- 2 Tap , then tap **Settings** > **Import**.
- 3 Select an import option.

Creating contacts

To create a new contact:

- 1 Tap .

2 Tap  .

3 Enter the contact's name, phone number and other contact information, and then tap  .

Searching for contacts

To search for contacts:

1 Tap  .

2 Use one of the following search methods:

- Scroll up or down the contacts list.
- Tap  at the top of the screen to search for a contact.

3 Select a contact. You can now call them, send them a text message, or edit their contact information.

Messages

Sending messages

To send messages:

1 Tap  .

2 Tap  to create a message.

3 Add recipients and enter a message.

4 Tap  to send the message.

Viewing messages



To view messages:

- 1 Tap  .
- 2 Select a contact on the message list.
- 3 View your conversation.

Camera



Taking photos

To take photos:

- 1 Tap  .
- 2 Spread two fingers apart on the screen to zoom in, and pinch to zoom out.
- 3 Tap  to take a photo. Your picture will be automatically saved to  .

Recording videos

To record videos:

- 1 Tap  .
- 2 Tap  to start recording the video. Spread two fingers apart on the screen to zoom in, and pinch to zoom out.
- 3 Tap  to finish recording.

Photos

Viewing photos or videos

To view photos or videos:

- 1 Tap  .
- 2 Select a photo or a video.

Deleting photos or videos

To delete photos or videos:

- 1 Tap  .

2 Tap and hold the photo or video that you want to delete, tap  .

Sharing photos or videos

To share photos or videos:

1 Tap  .

2 Select the photo or video that you want to share.

3 Tap  . Select your sharing method.

Chrome

Using Chrome

Connect the web to search for information and bookmark your favorite web pages to access them conveniently.

1 Tap  .

2 Enter the address field in the search bar. You will have access to web pages; moreover, bookmarks, multiple window switching and other functions are supported.

Clock

This app includes the following functions:

Alarm

1 Tap  .

2 Tap  .

3 you can do the following steps to set your alarms:

Adding an alarm

Tap  and set the alarm time, repeat times, alarm sound, and others.

Enabling or disabling an alarm

Turn on or turn off the switch next to an alarm.

Configuring the alarm settings

Tap  > **Settings** to configure the alarms.

Deleting an alarm

Tap the alarm that you want to delete. Then tap  .

Clock

1 Tap  .

2 Tap  .

3 you can do the following steps to set your clock:

Adding a city

Tap  . Enter a city name in the search bar or select a city from the list.

Deleting a city



Tap  . Deselect the city, then the clock of the city will be

deleted.

Timer

1 Tap .

2 Tap .



3 Set the countdown time and tap  to start the timer. Tap  to pause the countdown.

Stopwatch

1 Tap .

2 Tap .

3 Tap  to start the stopwatch. Tap  to count laps.

Tap  to pause the stopwatch. Tap  to reset the stopwatch.

Sound Recorder

The device supports long periods of recording. Make sure your device has available storage before recording.

Recording sound



1 Tap .

2 Tap  to start recording.



3 Tap  to stop recording, then tap  Save, the recording

file is automatically saved in the phone. Tap  Delete, the recording file is deleted.

Playing a recording

- 1 Tap .
- 2 Tap  to find your recording.
- 3 Tap  to play the recording.

Managing recordings

- 1 Tap .
- 2 Tap .
- 3 Tap and hold a recording. You can rename, share or delete the recording file.

Calculator

Use calculator to do simple or complicated calculations.

Making calculation

Tap , you can do simple calculations:

- Tap the number and calculate sign to do simple calculations.
- Go to advanced calculator tab by swiping your screen left.

FM Radio

Listening to radio

To use the FM Radio, first you need to connect your headphones.

- 1 Tap  to activate.
- 2 Select the frequency following the app instructions and set the volume to a comfortable level.

Safety

This section contains information on the secure and safe operation of your phone.

Safety precautions

For your safety and that of others, ensure you read, understand, and follow all of the information in this section.



Failure to obey the following safety information could result in fire, electric shock, injuries, or damage to your device or other property. Read all the safety information below before using your phone.

- Using unapproved or incompatible power adapters, chargers, or batteries may damage your phone, shorten its lifespan, or cause a fire, explosion, or other hazards.
- Your phone's ideal operating temperature is 0°C to 35°C. Your phone's ideal storage temperature is -20°C to 45°C.

- Pacemaker manufacturers recommend keeping a minimum distance of 15 cm between phone and pacemaker to prevent potential interference with the pacemaker. If you use a pacemaker, hold your phone on the side opposite to your pacemaker and do not carry your phone in your front pocket.
- Keep your phone and battery away from excessive heat and direct sunlight. Do not place your phone or battery on or in heating devices, such as microwave ovens, stoves, or radiators.
- Do not use your phone in a moist environment, such as bathroom. Prevent your phone from being soaked or washed in liquid.
- Follow local laws and regulations while using your phone. To reduce the risk of accidents, do not use your wireless phone while driving.
- While flying in an aircraft or immediately before boarding, only use your phone according to instructions provided. Use of a wireless phone in an aircraft may disrupt wireless networks, can cause danger to aircraft operation, and may be illegal.
- To prevent damage to your phone's parts or internal circuits, do not use it in dusty, smoky, damp, or dirty environments or near magnetic fields.
- When charging your phone, plug the adapter into a socket which is near your phone and which is easy to reach.

- When not in use, unplug the charger from outlets and from the phone.
- Do not use, store or transport your phone in areas where flammables or explosives are stored (in a gas station, oil depot, or chemical plant, for example). Using your phone in these environments increases the risk of explosion or fire.
- Dispose of your phone, battery, and accessories according to local regulations. Do not throw phones or batteries away in your household trash bin or other non-recycling trash bin. Improper battery use or disposal may lead to fire, explosion, or other hazards.
- Consult your doctor and the device manufacturer to determine if operation of your phone may interfere with the operation of your medical device.
- Obey any rules or regulations set by hospitals and health care facilities.
- Do not crash, throw, puncture, drop, squeeze, or bend your phone.
- Do not try to take apart your phone or its accessories. Only authorized personnel are allowed to service or repair the phone.
- Use a dry soft cloth to clean your phone. Do not use water, alcohol, detergent or any chemicals.

- Keep your phone and charger out of the reach of children. Do not let children use the phone or charger without supervision.
- Phone accessories and phone accessory parts, especially small parts, must also be kept away from children to prevent choking.
- Power off your phone in any area where there is a risk of explosions. Do not charge your phone or use your phone in areas where there are chemicals or particles in the air. Obey all signs and instructions.
- Strictly obey relevant instructions in this guide while using USB cable. Failure to follow instructions may result in your phone or PC being damaged.
- Only use USB version 2.0. USB equipment with your phone.

Safe cleaning and maintenance

To ensure your safety and that of others, you must pay attention to the following safety tips when cleaning and maintaining your phone:

- Turn off your phone before cleaning and maintenance. Your charger should be unplugged from socket. Your phone and charger should be disconnected to prevent electric shocks or short circuiting.
- Do not wipe your phone or charger with benzyl alcohol, chemical substances, chemical agents or abrasive cleaning agents. This is

to avoid damaging phone parts or the functioning of your phone.

You may clean your phone with a slightly damp anti-static cloth.

- Do not scrape or alter the phone case, or the paint on the phone, as it may cause allergic reaction. If such reaction occurs, stop using your phone immediately and seek medical help.
- Wipe dust off power plug and keep it dry to avoid risk of fire.
- If your phone or accessories do not work properly, contact your local vendor.
- Do not disassemble device or its accessories by yourself.

Safe battery charging

Follow the information on safe battery charging in the Battery charging, Safety precautions, and Protecting your battery sections of this user manual.

Protecting your hearing



- To prevent possible hearing damage, do not listen at high volume levels for long periods.
- Fully understand user manual before use.
- Ensure your player at low volume levels or power off before you leaving.

Protecting the environment



- Obey the local regulations on device packaging, battery and used device disposal and bring them to the collection point for proper recycling.
- Take your used, unwanted lithium batteries to a designated place. Do not dispose of used devices or batteries in a household rubbish bin.
- Proper collection and recycling of your device help ensure electrical and electronic equipment waste is recycled in a manner that conserves valuable materials and protects human health and the environment.

Specific Absorption Rate (SAR)

- Your phone is tested to comply with applicable requirements and regulations of the European Union of human exposure to radio wave.
- These requirements set a SAR limit of 2.0W/kg averaged over ten gram of tissue when use in head or Body, and set a SAR limit of 4.0 W/kg averaged over tengram of tissue when use in Limbs.
- Specific Absorption Rate (SAR) is used to measure radio waves absorbed by a body. The device complies with RF specifications

when the device used at a distance of 5 mm from your body.

- This product was tested and recorded the maximum SAR value was 0.687W/kg for the head, 1.588W/kg for the body.
- The actual SAR level will be much lower than above value since the device has been designed to use the minimum energy for necessary communication with the base station.

Reducing your radiation exposure

You can reduce your exposure to radiation from your phone by doing the following:

- Use your phone in areas with good reception. Be especially careful in underground car parks and on train and car journeys.
- Use your phone when all the signal strength bars are displayed.
- Use a hands-free kit.
- During calls, keep your phone away from your abdomen (for pregnant women) and your lower abdomen (for teenagers).

Other important information

Important data usage and billing information

Your phone regularly connects to mail and Internet servers to improve your experience. This creates data exchanges that may be charged along with your existing package, or which may use

prepaid credit.

To avoid billing problems related to Internet services, it is strongly recommended to use a suitable package or plan which includes unlimited Internet and emails and to avoid changing the default settings.

You can connect to Wi-Fi for faster, more streamlined service. If you can, use Wi-Fi for streaming, and for downloading games, videos and films.

Disclaimer

Unofficial headsets, chargers, and other accessories are not compatible with your phone. Using unofficial accessories can affect performance. The factory is in no way responsible for any damage that occurs as a result of using unofficial accessories.

This user manual is intended to provide a general overview. Actual specifications and functions of your phone may be different from those contained in the user manual.

Your phone was fully tested after production. If there are any damages or defects due to manufacturing, follow the terms and conditions in the warranty card.

If there are issues with your phones related to operator features and services, follow the operator terms and conditions.

Note that your phone has specification and function limitations.

These limitations cannot be considered manufacturer damage or as damage or defect of any kind.

Only use your phone for the purposes or functions for which it was designed.

THIS PRODUCT IS LICENSED UNDER THE AVC PATENT PORTFOLIO LICENSE FOR THE PERSONAL USE OF A CONSUMER OR OTHER USES IN WHICH IT DOES NOT RECEIVE REMUNERATION TO (i) ENCODE VIDEO IN COMPLIANCE WITH THE AVC STANDARD (“AVC VIDEO”) AND/OR (ii) DECODE AVC VIDEO THAT WAS ENCODED BY A CONSUMER ENGAGED IN A PERSONAL ACTIVITY AND/OR WAS OBTAINED FROM A VIDEO PROVIDER LICENSED TO PROVIDE AVC VIDEO. NO LICENSE IS GRANTED OR SHALL BE IMPLIED FOR ANY OTHER USE. ADDITIONAL INFORMATION MAY BE OBTAINED FROM MPEG LA, L.L.C. SEE [HTTP://WWW.MPEGLA.COM](http://www.mpegla.com)

Frequency bands and power

Mode	Frequency Bands	Tune-up Power
GSM850	Tx: 824-849MHz, Rx: 869-894MHz	33 dBm±2dB
GSM900	Tx: 880-915MHz, Rx: 925-960MHz	33 dBm±2dB
GSM1800	Tx: 1710-1785MHz, Rx: 1805-1880MHz	30 dBm±2dB
GSM1900	Tx: 1850-1910MHz, Rx: 1930-1990MHz	30 dBm±2dB
WCDMA Band I	Tx: 1920-1980MHz, Rx: 2110-2170MHz	23.0 dBm±2dB
WCDMA Band II	Tx: 1850-1900MHz, Rx: 1930-1980MHz	23.0 dBm±2dB
WCDMA Band VIII	Tx: 880-915MHz, Rx: 925-960MHz	23.0 dBm±2dB
WIFI	2412-2472MHz for 802.11b/g/n(HT20)	16.0 dBm±3dB
Bluetooth	2402-2480MHz	≤8.0dBm
GPS	1575.42MHz Receiving	
FM	87.5~108.0MHz Receiving	

Compliance



Wi-Fi(WLAN)

This equipment may be operated in all European countries.

Copyright

Copyright © 2020 Casper

The user manual is protected under international copyright laws.

No part of the user manual may be reproduced, distributed, translated, or transmitted in any form or by any means, electronic or mechanical, including photocopying, recording, or storing in any information storage and retrieval system, without the prior written permission of Group. Some of the contents of the user manual may not apply to your device, depending on the software and your service provider. All information in this document is subject to change without notice.

EU Declaration of Conformity (DoC)

RED Directive 2014/53/EU

We,
Hisense International Co., Ltd.

hereby, declare that the essential requirements set out in the **RED Directive 2014/53/EU** have been fully fulfilled on our product with indication below:

Product Name: Mobile Phone

Brand Name: Hisense

Model No.: HWCD119E

The following standards have been applied for the investigation of compliance:

ETSI EN 301 511 V12.5.1 (2017-03)

ETSI EN 301 908-1 V15.2.1 (2023-01)

ETSI EN 301 908-2 V13.1.1 (2020-06)

ETSI EN 300 328 V2.2.2 (2019-07)

ETSI EN 303 413 V1.2.1 (2021-04)

ETSI EN 303 345-1 V1.1.1 (2019-06)

ETSI EN 303 345-3 V1.1.1 (2021-06)

EN 55032:2015+A1:2020; EN 55035:2017+A11:2020

EN IEC 61000-3-2:2019+A1:2021; EN 61000-3-3:2013+A2:2021

ETSI EN 301 489-1 V2.2.3 (2019-11)

ETSI EN 301 489-17 V3.2.4 (2020-09)

ETSI EN 301 489-19 V2.2.1 (2022-09)

ETSI EN 301 489-52 V1.2.1 (2021-11)

EN 50663:2017

EN 62209-1:2016 EN 62209-2:2010+AMD1(2019)

EN 50360:2017 EN 50566:2017

EN 50332-1:2013

EN 50332-2:2013

EN 62368-1:2014+A11:2017

And apply notified body assessment:

Notified Body number 0700

PHOENIX TESTLAB GmbH

Königswinkel 10

D-32825 Blomberg

Germany

Software Version:	Hisense_HWCD119E_S03_01_01_ZA01
Hardware Version:	A507-MB-V1.7
System Components	
Component 1	Rechargeable Li-ion Battery Model: LPW380300 3.8V, 2900mAh, 11.02Wh SHENZHEN UTILITY ENERGY CO., LTD.
Component 2	Rechargeable Li-ion Battery Model: LPW380300 3.8V, 2900mAh, 11.02Wh Phenix New Energy (Huizhou) Co., Ltd.
Optional Components	
Optional 1	AC Adapter Model: TPA- 97050100V01 Input: 100-240V~, 50/60Hz, 0.15A Output: 5.0V 1.0A, 5W Shenzhen Tianyin Electronics Co., Ltd.
Optional 2	Earphone Cable (1.0m, Unshielded, Without Ferrite) Dongguan Keling Electronic Technology Co., Ltd.

Furthermore, the ISO requirement for the in-process quality control procedure as well as the manufacturing process has been reached. The technical document as well as the test reports will be kept for a period at least 10 years after the last product has been manufactured at the disposal of the relevant national authorities of any Member State for inspection. Detail contact information for this declaration has been listed below as the window of any issues relevant for this declaration.

Manufacturer Contact

Company: Hisense International Co., Ltd.

Address: No.218, Qianwangang Road, Economic and Technological Development Zone, Qingdao, Shandong Province, China

Name & Title: Zhang He/Manager

Tel No.: +86-532-55753718

Fax No.: --

E-mail: zhanghe1@hisense.com



Mark Zhang

Date: 2023.11.27